



Operation Manual

Smart-UPS[™] C Uninterruptible Power Supply

1000/1500/2000/3000 VA

120/230 Vac

Rack-Mount 2U

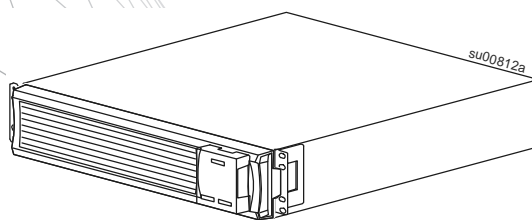

Important Safety Messages

SAVE THESE INSTRUCTIONS - This manual contains important instructions that should be followed during installation and maintenance of the Power Management Unit, Service Bypass Unit and batteries.

Read the instructions carefully and look at the equipment to become familiar with the device before trying to install, operate, service or maintain it. The following special messages may appear throughout this document or on the equipment to warn of potential hazards or to call attention to information that clarifies or simplifies a procedure.



The addition of this symbol to a Danger or Warning product safety label indicates that an electrical hazard exists that will result in personal injury if the instructions are not followed.



This is the safety alert symbol. It is used to alert you to potential personal injury hazards. Obey all safety messages that follow this symbol to avoid possible injury or death.

DANGER

DANGER indicates a hazardous situation which, if not avoided, will result in death or serious injury.

WARNING

WARNING indicates a hazardous situation which, if not avoided, could result in death or serious injury.

CAUTION

CAUTION indicates a hazardous situation which, if not avoided, could result in minor or moderate injury.

NOTICE

NOTICE is used to address practices not related to physical injury.

Safety and General Information

Inspect the package contents upon receipt.

Notify the carrier and dealer if there is any damage.

- Adhere to all national and local electrical codes.
- All wiring must be performed by a qualified electrician.
- Changes and modifications to this unit not expressly approved by Schneider Electric could void the warranty.
- This UPS is intended for indoor use only.

- Do not operate this unit in direct sunlight, in contact with fluids, or where there is excessive dust or humidity.
- Be sure the air vents on the UPS are not blocked. Allow adequate space for proper ventilation.
- The equipment is heavy. Always practice safe lifting techniques adequate for the weight of the equipment.

Battery safety

- It is not necessary to ground the battery system. The user has the option of referencing the battery system to chassis ground at either a positive or negative battery terminal.
- When replacing batteries, replace with the same number and type.
- Batteries typically last for two to five years. Environmental factors impact battery life. Elevated ambient temperatures, poor quality utility power, and frequent short duration discharges will shorten battery life. Batteries should be replaced before end of life.
- Replace batteries immediately when the unit indicates battery replacement is necessary.
- Schneider Electric uses Maintenance-Free sealed Lead Acid batteries. Under normal use and handling, there is no contact with the internal components of the battery. Over charging, over heating or other misuse of batteries can result in a discharge of battery electrolyte. Released electrolyte is toxic and may be harmful to the skin and eyes.
- CAUTION: Before installing or replacing the batteries, remove jewelry such as wristwatches and rings.
High short circuit current through conductive materials could cause severe burns.
- CAUTION: Do not dispose of batteries in a fire. The batteries may explode.
- CAUTION: Do not open or mutilate batteries. Released material is harmful to the skin and eyes and may be toxic.

Deenergizing safety

The UPS contains internal batteries and may present a shock hazard even when disconnected from the branch circuit (mains). Before installing or servicing the equipment check that the:

- Input circuit breaker is in the **OFF** position.
- Internal UPS batteries are removed.

Radio Frequency Warning

This product has been tested and found to be category C2 device. This equipment generates, uses, and can radiate radio frequency energy and, if not installed and used in accordance with the instruction manual, may cause harmful interference to radio communications. Operation of this equipment is likely to cause radio interference with some communication devices like TV, mobiles, audio equipments, radio receivers, etc. Generally this issue can be corrected by moving the equipment a little away from the UPS, however sometimes additional measures may have to be taken at user's expense.





Product Description

The APC™ by Schneider Electric Smart-UPS™ C is a high performance uninterruptible power supply (UPS). The UPS provides protection for electronic equipment from AC power blackouts, brownouts, sags, and surges, small AC power fluctuations and large disturbances. The UPS also provides battery backup power for connected equipment until AC power returns to acceptable levels or the batteries are completely discharged.

This user manual is available on the enclosed Documentation CD and on the APC by Schneider Electric web site, www.apc.com.

Specifications

For additional specifications, refer to the APC by Schneider Electric web site at www.apc.com.

The UPS and battery is heavy. Follow all lifting guidelines.			
Lifting guidelines	 < 18 kg (< 40 lb)	 18 - 32 kg (40 - 70 lb)	 32 - 55 kg (70 - 120 lb)
Weight specifications	UPS + Battery		Battery
	1000 VA models 20.48 kg (45.15 lb)		5.6 kg (12.32 lb)
	1500 VA models 27.8 kg (61.20 lb)		10 kg (22 lb)
	2000 VA models 26.2 kg (57.76 lb)		10 kg (22 lb)
	3000 VA models 41 kg (90.38 lb)		19 kg (41.80 lb)
Temperature	Operating		0° to 40° C (32° to 104° F)
	Storage		-15° to 45° C (5° to 113° F) charge UPS battery every six months
Maximum Elevation	Operating		3,000 m (10,000 ft)
	Storage		15,000 m (50,000 ft)
Humidity	0% to 95% relative humidity, non-condensing		0° to 40° C (32° to 104° F)
Battery Type	Maintenance free, sealed lead acid		
 	<p>Replace used batteries with APC by Schneider Electric approved batteries. To order a replacement battery go to the APC by Schneider Electric web site, www.apc.com.</p> <p>Always recycle used batteries.</p> <p>For information on recycling a used battery, refer to the Battery Disposal Information sheet included with the replacement battery.</p>		

Product Overview

Front panel features

- 1 Display interface
- 2 Bezel
- 3 Battery
- 4 Internal battery connector

1000VA 120/230 Vac

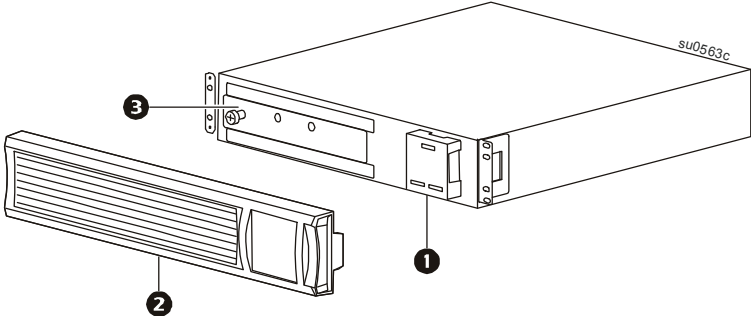

3000 VA 230 Vac

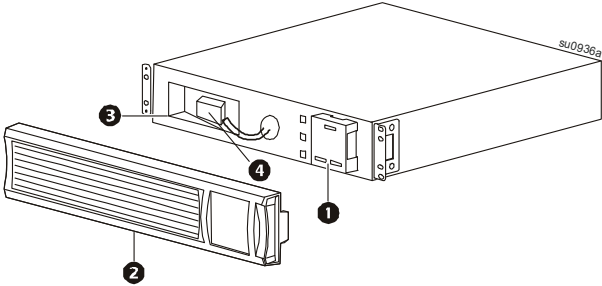

1500 VA 120/230 Vac
2000 VA 230 Vac

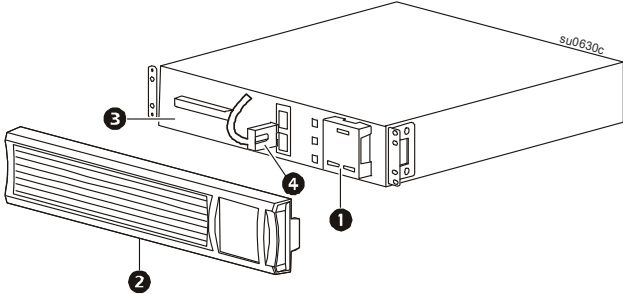

Rear panel features

- ❶ UPS input
- ❷ Circuit breaker/Overload protection
- ❸ Chassis ground screw
- ❹ Outlets
- ❺ USB port
- ❻ Serial data port

1000 VA 120 Vac

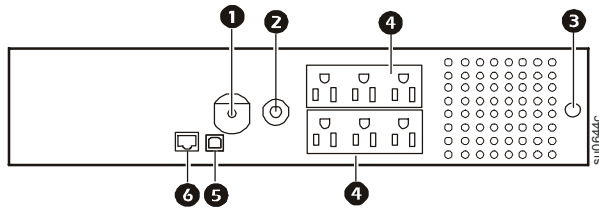

1000 VA 230 Vac

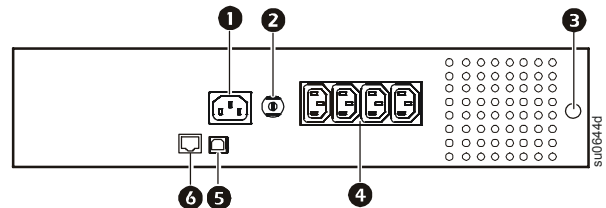

1500 VA 120 Vac

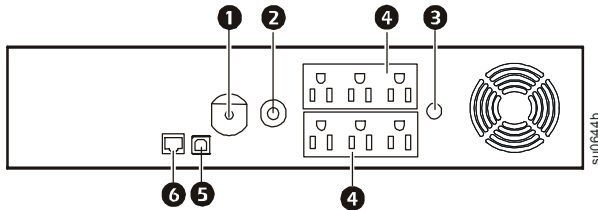

1500 VA 230 Vac

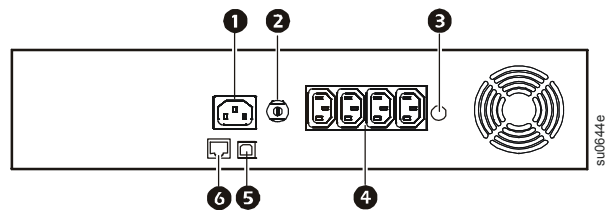

- ❶ UPS input
- ❷ Circuit breaker/Overload protection
- ❸ Chassis ground screw
- ❹ Outlets
- ❺ USB port
- ❻ Serial data port

2000 VA 230 Vac

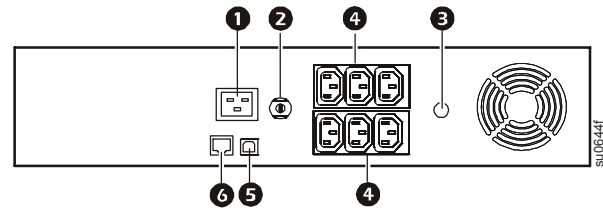

3000 VA 230 Vac

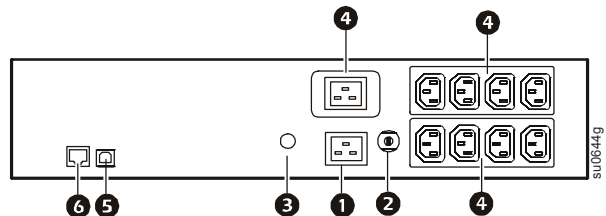

Installation

For UPS installation information, refer to the Installation Guide for the Smart-UPS C 1000/1500/2000/3000 VA Rack-Mount 2U included with the UPS.

The Installation Guide is also available on the Documentation CD included with the UPS and on the APC by Schneider Electric web site, www.apc.com.

Operation



Note: The UPS will charge to 90% capacity in the first three hours of normal operation.
Do not expect full battery runtime capability during this initial charge period.

1. Connect equipment to the UPS.
2. Connect the UPS to a two pole, three wire, grounded source.

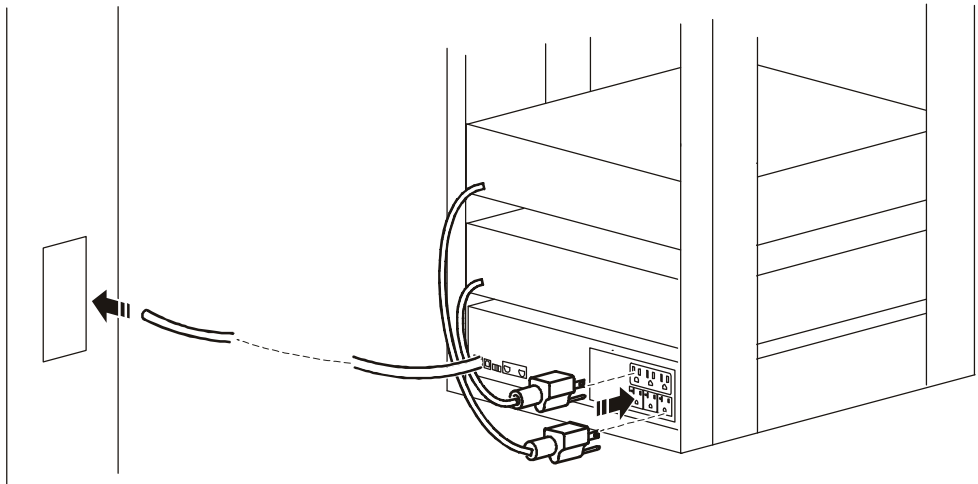
⚠ CAUTION	
RISK OF ELECTRIC SHOCK	
<ul style="list-style-type: none"> • Adhere to all local and national electrical codes. • Wiring must be performed by qualified electrician. • Always connect the UPS to a grounded outlet. 	
Failure to follow these instructions can result in minor or moderate injury	



Connect equipment to the UPS



	USB port: Connect to a computer to use power management software.
	Serial port: Connect a serial port cable (not supplied) to use power management software.
	Chassis ground screw: Connect the ground leads on transient voltage devices to the chassis ground screw(s), located on the rear panel of the UPS.

Sensitivity adjustment settings

The UPS detects and reacts to line voltage distortions by transferring to battery backup power to protect connected equipment. In situations where the connected equipment is too sensitive for the input voltage level it is necessary to adjust the transfer voltage.

1. Connect the UPS to a AC power source. Be sure the UPS is turned off.
2. Place the unit in Configuration Mode, as described in page 10.
3. Use the Sensitivity Setting option to set the transfer voltage range.

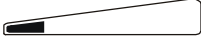
When the UPS is in **Configuration Mode**, the **Sensitivity** bar graph icons display the sensitivity level setting. Refer to the examples here as a reference.

		
Low sensitivity	Medium sensitivity	High sensitivity (Default)
120 Vac: 97-136 Vac	120 Vac: 103-130 Vac	120 Vac: 106-127 Vac
230 Vac: 195-265 Vac	230 Vac: 203-257 Vac	230 Vac: 207-253 Vac
Use this setting with equipment that is less sensitive to fluctuations in voltage or waveform distortions.	Use this setting under normal operating conditions.	Use this setting when connected equipment is sensitive to any minor fluctuations in voltage or waveform distortions.

Status Indicators



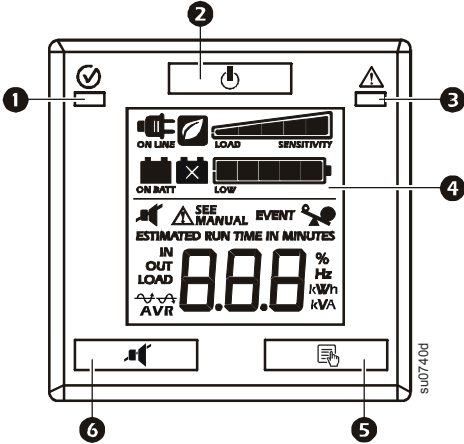
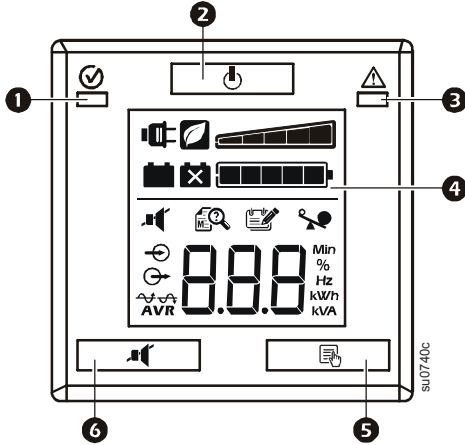



Display panel features

120 Vac	230 Vac
	
1 On Line/On Battery LED	4 Display interface
2 POWER ON/OFF button	5 DISPLAY button
3 Site Wiring Fault/System Alert LED	6 MUTE button
Note: Refer to “Feature Reference Guide” on page 10 in this manual for a detailed description of the front panel buttons and icons.	



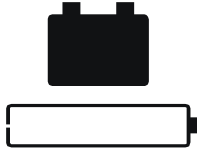











LED status indicators

Status	LED	Audible Indicator On	Audible Indicator Terminates
Power On The UPS is supplying AC power to connected equipment.	The On Line/On Battery LED illuminates green.	None	N/A
On Battery The UPS is supplying battery power from the internal battery.	The On Line/On Battery LED illuminates amber.	The UPS beeps 4 times every 30 seconds.	The beeping stops when AC power is restored or the MUTE button is pressed for two seconds.
System Alert The UPS has detected an internal error.	System Alert LED illuminates red.	Constant tone	The alarm stops when the POWER ON/OFF button is pressed for two seconds. This creates a Reset .
Site Wiring Fault A building wiring fault has occurred. Do not operate the UPS. Contact a qualified electrician to correct the building wiring fault.	Site Wiring Fault LED flashes red.	None	N/A

LCD status indicators

Status	LCD Icon	Audible Alarms	Audible Alarm Terminates
On Battery The UPS is supplying battery power to the connected equipment.		Beeps 4 times every 30 seconds.	The beeping stops when AC power is restored or the UPS is turned off.
AC Power Overload An overload condition has occurred while the UPS is operating on AC power.		Constant tone	The alarm stops when nonessential equipment is disconnected from the outlets or the UPS is turned off
Battery Power Overload An overload condition has occurred while the UPS is operating on battery power.		Constant tone	The alarm stops when nonessential equipment is disconnected from the outlets or the UPS is turned off.
Low Battery The UPS is supplying battery power to the connected equipment and the battery is near a total discharge state.		Continuous beeping	The beeping stops when AC power is restored or the UPS is turned off.
Battery Alert The UPS is operating on AC power. The battery does not provide expected backup.		The UPS will beep twice to indicate the battery is disconnected. The UPS will beep continuously for one minute every five hours to indicate that the battery should be replaced.	Verify that the battery is securely connected. The battery is nearing the end of its service life and should be replaced.
System Alert The UPS has detected an internal error.	120 Vac models  SEE MANUAL 230 Vac models 	N/A	Identify the alert message on the display and refer to System Alerts in this manual.



Display icons

120 Vac	230 Vac	Description
 ON LINE		On Line: The UPS is supplying conditioned AC power to connected equipment.
		Green mode: The UPS is operating at the most efficient level, bypassing unused AVR components while acceptable AC voltage is present. The UPS will enter and exit Green mode automatically and will not compromise power protection.
		Load Capacity: The load capacity percentage is indicated by the number of load bar sections illuminated. Each bar represents 20% of the load capacity.
ESTIMATED RUN TIME IN MINUTES	Min	Estimated Run Time / Min: This indicates the battery runtime minutes that remain if the UPS switches to battery power.
		Battery Charge: The battery charge level is indicated by the number of load bar sections illuminated. When all five blocks are illuminated, the battery is fully charged. Each bar represents 20% of the battery charge capacity.
		Overload: The equipment connected to the UPS is drawing more power than the voltage rating allows.
EVENT		Event: The event counter indicates the number of events that occurred to cause the UPS to switch to battery operation.
		<p>Automatic Voltage Regulation (AVR): The UPS has an AVR boost and trim feature that automatically regulates high or low levels of input voltage without using battery power. The UPS also features AVR Bypass which temporarily deactivates the AVR circuitry when the input voltage is within normal range. This conserves battery power and helps to maximize battery life.</p> <p> When illuminated, the UPS is compensating for low input voltage.</p> <p> When illuminated, the UPS is compensating for high input voltage.</p>
IN OUT		In: Input voltage. Out: Output voltage.
		System Alert: The UPS has detected an internal fault. The alert number will illuminate on the display. Refer to “Display icons” on page 9.
		Mute: An illuminated line through the icon indicates that audible alarms are disabled.
		Battery Alert: The icon will flash to indicate that the battery is disconnected. When the icon remains continuously illuminated the UPS has not passed a Self-Test or the battery is near the end of its service life and should be replaced. Refer to “LCD status indicators” on page 8.



On Battery: The UPS is supplying battery backup power to the connected equipment.

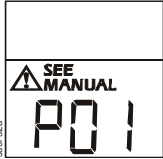



System Alerts

<p>120 Vac</p> 	<p>230 Vac</p> 	P00	Output Overload
		P01	Output Short Circuit
		P02	Output Over Voltage
		P04	Unit Over Temperature
		P06	AVR Relay Alert
		P13	Inverter Alert



For more information on System Alerts, contact customer support at the APC by Schneider Electric web site, www.apc.com/support.

Feature Reference Guide

Normal Mode





Function	Button	Timing (seconds)	UPS State	Description
Power				
Power On		0.2	Off	Press the POWER ON/OFF button to turn on the UPS. The UPS will operate on AC power. If AC power is not available the UPS will operate on battery power.
Power Off		2	On	Press the POWER ON/OFF button to turn off the UPS.
Display				
Status Inquiry		0.2	On	Press to verify the status or condition of the UPS. The LCD will illuminate for 60 seconds.
Mute				
Enable/Disable		2	On	Enable or disable the audible alarms. The Mute icon will illuminate and the UPS will beep once.
Reset		2	Alert	After an alert has been identified, press the POWER ON/OFF button to remove the visual indication and return to standby status.

Configuration Mode

The Configuration Mode provides additional options for the UPS. Press and hold the MUTE  and DISPLAY  buttons for 2 seconds until the system emits a short beep and the display will flash to indicate the UPS has entered Configuration Mode.

When in Configuration Mode the DISPLAY button forwards the display through the available options and the MUTE button toggles the configuration settings for that option.

Note: When system detects 15 seconds of no activity in Configuration Mode, or when you press and hold the MUTE and DISPLAY buttons for 2 seconds until the system emits a short beep, the program automatically exits and returns to Normal mode.

Function	Options	Description
Self-Test	<ul style="list-style-type: none"> • 0: Default Setting • 1: Begin Self-Test 	<p>When set to 1, pressing the DISPLAY button will trigger the self test and exit the Configuration Mode.</p> <p>0 is the default setting and will not initiate a self test, by pressing the DISPLAY button you will advance to the next configuration item.</p> <p>Note: When the UPS is in Configuration mode and the UPS output power is off, a Self-Test cannot be initiated.</p>
Sensitivity Setting	<ul style="list-style-type: none"> • High  • Medium  • Low  	<p>Select the Sensitivity range depending on the desired quality of input AC power:</p> <ul style="list-style-type: none"> • If High is selected, the unit will go on battery power more often to provide the cleanest power supply to the connected equipment. • If Medium is selected, the UPS is under normal operating conditions. • If Low is selected, the UPS will tolerate more fluctuations in power and will go on battery power less often. <p>If unsure of the local power quality, select Low.</p>
Output Voltage Setting <small>* 230V models only</small>	<ul style="list-style-type: none"> • 220 Vac • 230 Vac • 240 Vac 	<p>Select the appropriate voltage of outlets when the UPS is in Standby mode.</p>
LCD Display Dimmer	<ul style="list-style-type: none"> • Load Bar Icon shows 100% = Always On.  • Load Bar Icon shows 0% = Auto Dim.  	<p>When the LCD Display Dimmer is configured to Auto Dim the LCD will illuminate if a button is pressed or an event occurs, then will automatically dim after 60 seconds of no activity.</p>
Green Mode Enable	<ul style="list-style-type: none"> • 0: Disable • 1: Enable 	<p>When Green Mode is enabled the UPS is operating at the most efficient level by bypassing unused AVR components while acceptable AC voltage is present. The UPS will enter and exit Green mode automatically while Enabled.</p>
Clear Event Counter	<ul style="list-style-type: none"> • NA 	<p>Pressing the MUTE button will clear the event counter.</p>

Troubleshooting

Problem and Possible Cause	Solution
The UPS will not turn on or there is no output	
The UPS has not been turned on.	Press the ON button once to turn on the UPS.
The UPS is not connected to AC power.	Be sure the power cable is securely connected to the UPS and to the AC power supply.
The input circuit breaker has tripped.	Disconnect nonessential equipment and reset the circuit breaker.
The UPS shows very low or no AC input voltage.	Check the AC power supply to the UPS by plugging in a table lamp. If the light is very dim, check the AC voltage.
The battery is not securely connected.	Be sure that all battery connections are secure.
The UPS has detected an internal fault.	Do not attempt to use the UPS. Unplug the UPS and have it serviced immediately.
The UPS is operating on battery while connected to AC power	
The input circuit breaker has tripped.	Disconnect nonessential equipment and reset the circuit breaker.
There is very high, very low, or distorted input line voltage.	Move the UPS to a different outlet on a different circuit. Test the input voltage with the AC voltage display. If acceptable to the connected equipment, reduce the UPS sensitivity.
The UPS is beeping	
The UPS is operating normally.	None. The UPS is protecting the connected equipment.
The UPS does not provide expected battery backup time	
The UPS battery is weak due to a recent power outage or is near the end of its service life.	Charge the battery. Batteries require recharging after an extended outage. Elevated ambient temperatures, poor quality AC power, and frequent short duration discharges will shorten battery life. If the battery is near the end of its service life, consider replacing the battery even if the replace battery icon is not illuminated.
The UPS is experiencing an overload condition.	Check the UPS load display. Unplug nonessential equipment, such as printers.
The Alert LED is illuminated, the UPS displays an alert message and emits a constant beeping	
The UPS has detected an internal fault.	Do not attempt to use the UPS. Turn the UPS off and have it serviced immediately. If more than one alert is present the alert messages will be displayed alternately on display screen.
The Replace Battery icon is illuminated	
The battery has a weak charge.	Allow the battery to recharge for at least four hours. Then, perform a Self-Test. If the problem persists after recharging, replace the battery.
The replacement battery is not properly connected.	Be sure the battery connector is securely connected.
Site Wiring Fault LED is flashing	
Wiring faults detected include missing ground, hot-neutral, polarity reversal, and overloaded neutral circuit.	If the UPS indicates a site wiring fault, have a qualified electrician inspect the building wiring. Applicable for 120 Vac units only.

Battery Replacement

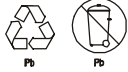

Always recycle used batteries.

For information on recycling a used battery, refer to the Battery Disposal Information sheet included with the replacement battery.

Battery life is highly dependent on temperature and use. To identify when to replace batteries, Smart-UPS have a predictive battery replacement date indicator in the “About” menu and automatic (and configurable) self-tests.

Proactively replace batteries to maintain the highest availability. To ensure protection and high performance, use only genuine APC replacement battery cartridges (RBC™). The APC RBC contains instructions for battery replacement and disposal. To order a replacement battery go to the APC by Schneider Electric Web site, www.apc.com.

UPS Model	Replacement Battery
SMC1000-2U	APCRBC124
SMC1000I-2U	
SMC1000I-2URS	
SMC1500-2U	APCRBC132
SMC1500I-2U	
SMC2000I-2U	APCRBC133
SMC2000I-2URS	
SMC3000RMI2U	APCRBC151
SMC3000RMI2URS	

Transport

1. Shut down and disconnect all connected equipment.
2. Disconnect the unit from utility power.
3. Disconnect all internal and external batteries (if applicable).
4. Follow the shipping instructions outlined in the *Service* section of this manual.

Service

If the unit requires service, do not return it to the dealer. Follow these steps:

1. Review the *Troubleshooting* section of the manual to eliminate common problems.
2. If the problem persists, contact APC by Schneider Electric Customer Support through the APC web site, **www.apc.com**.
 - a. Note the model number and serial number and the date of purchase. The model and serial numbers are located on the rear panel of the unit and are available through the LCD display on select models.
 - b. Call APC Customer Support and a technician will attempt to solve the problem over the phone. If this is not possible, the technician will issue a Returned Material Authorization Number (RMA#).
 - c. If the unit is under warranty, the repairs are free.
 - d. Service procedures and returns may vary internationally. Refer to the APC web site for country specific instructions.
3. Pack the unit properly to avoid damage in transit. Never use foam beads for packaging. Damage sustained in transit is not covered under warranty.
 - a. **Note: When shipping within the United States, or to the United States always DISCONNECT ONE UPS BATTERY before shipping in compliance with U.S. Department of Transportation (DOT) and IATA regulations.** The internal batteries may remain in the UPS.
 - b. Batteries may remain connected in the XBP during shipment. Not all units utilize XLBPs.
4. Write the RMA# provided by Customer Support on the outside of the package.
5. Return the unit by insured, prepaid carrier to the address provided by Customer Support.

Two Year Limited Factory Warranty

Schneider Electric IT Corporation (SEIT), warrants its products to be free from defects in materials and workmanship for a period of two (2) years from the date of purchase. The SEIT obligation under this warranty is limited to repairing or replacing, at its own sole option, any such defective products. Repair or replacement of a defective product or parts thereof does not extend the original warranty period.

This warranty applies only to the original purchaser who must have properly registered the product within 10 days of purchase. Products may be registered online at warranty.apc.com.

SEIT shall not be liable under the warranty if its testing and examination disclose that the alleged defect in the product does not exist or was caused by end user or any third person's misuse, negligence, improper installation, testing, operation or use of the product contrary to SEIT recommendations or specifications. Further, SEIT shall not be liable for defects resulting from: 1) unauthorized attempts to repair or modify the product, 2) incorrect or inadequate electrical voltage or connection, 3) inappropriate on site operation conditions, 4) Acts of God, 5) exposure to the elements, or 6) theft. In no event shall SEIT have any liability under this warranty for any product where the serial number has been altered, defaced, or removed.

EXCEPT AS SET FORTH ABOVE, THERE ARE NO WARRANTIES, EXPRESS OR IMPLIED, BY OPERATION OF LAW OR OTHERWISE, APPLICABLE TO PRODUCTS SOLD, SERVICED OR FURNISHED UNDER THIS AGREEMENT OR IN CONNECTION HERewith.

SEIT DISCLAIMS ALL IMPLIED WARRANTIES OF MERCHANTABILITY, SATISFACTION AND FITNESS FOR A PARTICULAR PURPOSE.

SEIT EXPRESS WARRANTIES WILL NOT BE ENLARGED, DIMINISHED, OR AFFECTED BY AND NO OBLIGATION OR LIABILITY WILL ARISE OUT OF, SEIT RENDERING OF TECHNICAL OR OTHER ADVICE OR SERVICE IN CONNECTION WITH THE PRODUCTS.

THE FOREGOING WARRANTIES AND REMEDIES ARE EXCLUSIVE AND IN LIEU OF ALL OTHER WARRANTIES AND REMEDIES. THE WARRANTIES SET FORTH ABOVE CONSTITUTE SEIT'S SOLE LIABILITY AND PURCHASER EXCLUSIVE REMEDY FOR ANY BREACH OF SUCH WARRANTIES. SEIT WARRANTIES EXTEND ONLY TO ORIGINAL PURCHASER AND ARE NOT EXTENDED TO ANY THIRD PARTIES.

IN NO EVENT SHALL SEIT, ITS OFFICERS, DIRECTORS, AFFILIATES OR EMPLOYEES BE LIABLE FOR ANY FORM OF INDIRECT, SPECIAL, CONSEQUENTIAL OR PUNITIVE DAMAGES, ARISING OUT OF THE USE, SERVICE OR INSTALLATION OF THE PRODUCTS, WHETHER SUCH DAMAGES ARISE IN CONTRACT OR TORT, IRRESPECTIVE OF FAULT, NEGLIGENCE OR STRICT LIABILITY OR WHETHER SEIT HAS BEEN ADVISED IN ADVANCE OF THE POSSIBILITY OF SUCH DAMAGES. SPECIFICALLY, SEIT IS NOT LIABLE FOR ANY COSTS, SUCH AS LOST PROFITS OR REVENUE, WHETHER DIRECT OR INDIRECT, LOSS OF EQUIPMENT, LOSS OF USE OF EQUIPMENT, LOSS OF SOFTWARE, LOSS OF DATA, COSTS OF SUBSTITUANTS, CLAIMS BY THIRD PARTIES, OR OTHERWISE.

NOTHING IN THIS LIMITED WARRANTY SHALL SEEK TO EXCLUDE OR LIMIT SEIT'S LIABILITY FOR DEATH OR PERSONAL INJURY RESULTING FROM ITS NEGLIGENCE OR ITS FRAUDULENT MISREPRESENTATION OF TO THE EXTENT THAT IT CANNOT BE EXCLUDED OR LIMITED BY APPLICABLE LAW.

To obtain service under warranty you must obtain a Returned Material Authorization (RMA) number from customer support. Customers with warranty claims issues may access the SEIT worldwide customer support network through the SEIT web site: www.apc.com. Select your country from the country selection drop down menu. Open the Support tab at the top of the web page to obtain information for customer support in your region. Products must be returned with transportation charges prepaid and must be accompanied by a brief description of the problem encountered and proof of date and place of purchase.

APC by Schneider Electric Worldwide Customer Support

Customer support for this or any other APC by Schneider Electric product is available at no charge in any of the following ways:

- Visit the APC by Schneider Electric Web site to access documents in the APC by Schneider Electric Knowledge Base and to submit customer support requests.
 - **www.apc.com** (Corporate Headquarters)
Connect to localized APC by Schneider Electric Web sites for specific countries, each of which provides customer support information.
 - **www.apc.com/support/**
Global support searching APC by Schneider Electric Knowledge Base and using e-support.
- Contact the APC by Schneider Electric Customer Support Center by telephone or e-mail.
 - Local, country-specific centers: go to **www.apc.com/support/contact** for contact information.
 - For information on how to obtain local customer support, contact the APC by Schneider Electric representative or other distributors from whom you purchased your APC by Schneider Electric product.



Select models are ENERGY STAR[®] qualified.
For more information on your specific model go to www.apc.com.

© 2017 APC by Schneider Electric. APC, the APC logo and APC, the APC logo, Smart-UPS and PowerChute are owned by Schneider Electric Industries S.A.S. or their affiliated companies. All other trademarks are property of their respective owners.